





Цанговые фитинги серий "RAP" и "Теспо-RAP".  
Резьбы М3 - G1/2". Трубки 2 - 14 мм.



**Артикул RDR**  
Прямой цанговый фитинг  
Никелированная латунь; Серия "RAP"

Код	ØD	G	ØC	H	L				
RDR3.20	2	M3	5,4	3,0	13,5			1,5	100
RDR3.30	3	M3	5,8	3,0	14,5			1,5	100
RDR5.20	2	M5	5,4	3,5	13,0			1,5	100
RDR5.30	3	M5	5,8	3,5	14,5			2,0	100
RDR5.40	4	M5	6,8	3,5	16,5			2,0	100

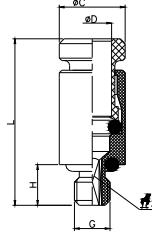

**Артикул 01**  
Прямой цанговый фитинг  
Никелированная латунь; Серия "RAP"

Код	ØD	G	ØC	ØB	H	L			
0104M5	4	M5	2,6	9,0	5,0	20,5	9	2,5	100
010418	4	G1/8"	2,6	13,5	6,0	20,0	9	2,5	50
010414	4	G1/4"	2,6	17,0	8,0	21,0	9	2,5	50
0105M5	5	M5	2,6	10	4,0	22,0		2,5	50
010518	5	G1/8"	4,2	13,5	6,0	22,0	10	4,0	50
010514	5	G1/4"	4,2	17,0	8,0	22,0	10	4,0	50
0106M5	6	M5	2,6	11,0	4,0	22,8	11	2,5	50
010618	6	G1/8"	4,2	13,5	6,0	25,3	11	4,0	50
010614	6	G1/4"	4,2	17,0	8,0	24,3	11	4,0	50
010818	8	G1/8"	5,2	12,8	6,0	27,0	13	5,0	50
010814	8	G1/4"	6,2	17,0	8,2	25,5	13	6,0	50
010838	8	G3/8"	6,2	20,0	9,0	25,5	13	6,0	50
011014	10	G1/4"	7,3	16,0	8,0	30,4	16	7,0	50
011038	10	G3/8"	8,3	21,0	9,0	30,9	16	8,0	50
011012	10	G1/2"	14,1	-	10	24,7	24	8	25
011214	12	G1/4"	7,3	16,0	8,0	33,2	19	7,0	25
011238	12	G3/8"	10,3	22,0	9,0	33,2	19	10,0	25
011212	12	G1/2"	10,3	24,0	11,0	33,2	19	10,0	25
011438	14	G3/8"	10,3	21,0	9,0	35,0	21	10,0	25
011412	14	G1/2"	10,3	24,0	11,0	32,5	21	10,0	25

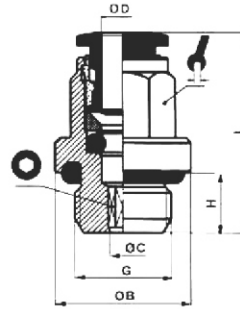

**Артикул 01C**  
Прямой цанговый фитинг  
Никелированная латунь; Серия "RAP"

Код	ØD	G	H	L				
01C0418	4	R1/8"	7,5	18	10	2,5	50	
01C0414	4	R1/4"	9,5	16	14	2,5	50	
01C0438	4	R3/8"	7,5	17,4	17	3	25	
01C0618	6	R1/8"	7,5	19,5	12	4,0	50	
01C0614	6	R1/4"	9,5	22,3	14	4,0	50	
01C0638	6	R3/8"	10,5	20,3	17	4	25	
01C0612	6	R1/2"	10	23,2	24	4	25	
01C0818	8	R1/8"	7,5	25,5	14	5,0	50	
01C0814	8	R1/4"	9,5	24,5	14	6,0	50	
01C0838	8	R3/8"	10,5	21,5	17	6,0	50	
01C0812	8	R1/2"	12,5	25,5	21	6	25	
01C1018	10	R1/8"	7,5	29,5	17	4	25	
01C1014	10	R1/4"	9,5	30,8	17	7,0	50	
01C1038	10	R3/8"	10,5	28,3	17	8,0	50	
01C1012	10	R1/2"	13,5	26,6	21	8,0	50	
01C1218	12	R1/8"	7	31	21	4	25	
01C1214	12	R1/4"	9,5	33	21	7,0	25	
01C1238	12	R3/8"	10,5	30	21	10,0	25	
01C1212	12	R1/2"	13,5	32,5	21	10,0	25	
01C1438	14	R3/8"	9,0	37,5	21	10,0	25	
01C1412	14	R1/2"	11,0	35,0	22	10,0	25	

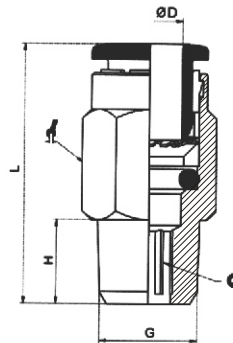

**Артикул T01**  
Прямой цанговый фитинг  
Технополимер; серия "Теспо-RAP"

Код	ØD	G	ØC	ØB	H	L			
T010418	4	G1/8"	2,5	14	5,5	19	10	2,5	50
T010414	4	G1/4"	2,5	17,5	6,5	20,8	10	4,0	50
T010618	6	G1/8"	4	14	5,5	24,5	12	5,0	50
T010614	6	G1/4"	4	17,5	6,5	26	12	2,5	50
T010818	8	G1/8"	5	14	5,5	25,7	14	4,0	50
T010814	8	G1/4"	6	17,5	6,5	27,2	14	6,0	50
T011014	10	G1/4"	7	17,5	6,5	28,7	18	7,0	50

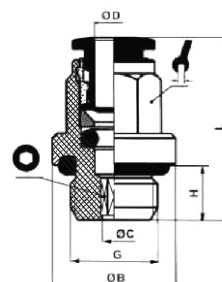



Цанговые фитинги серий "RAP" и "Теспо-RAP".  
Резьбы M5 - G1/2". Трубки 4 - 14 мм.



**Артикул 02**

Прямой цанговый фитинг с внутренней резьбой  
Никелированная латунь; Серия "RAP"

Код	ØD	G	ØC	ØB	H	L		
0204M5	4	M5	5,0	9,0	4,5	23,0	9	50
020418	4	G1/8"	3,0	12,0	6,5	26,5	9	50
020414	4	G1/4"	3,0	17,0	10,0	29,5	9	50
020618	6	G1/8"	5,0	12,0	6,5	28,3	11	50
020614	6	G1/4"	5,0	17,0	10,0	31,3	11	50
020818	8	G1/8"	7,0	12,0	6,5	28,5	13	50
020814	8	G1/4"	7,0	17,0	10,0	32,5	13	50

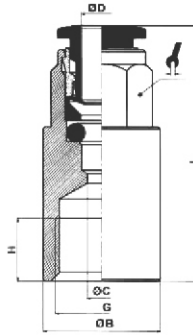

1

1

**Артикул 03**

Цанговый соединитель трубок

Никелированная латунь; Серия "RAP"

Код	ØD	ØB	ØC	L	
030400	4	3,0	11,0	32,0	50
030600	6	5,0	13,0	36,1	50
030800	8	7,0	15,0	38,0	50
031000	10	9,0	18,0	42,3	50
031200	12	11,0	21,0	45,8	25
031400	14	13,0	23,0	48,9	25

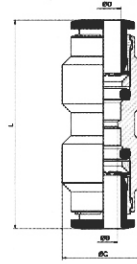

**Артикул T03**

Соединитель трубок цанговый

Технополимер; серия "Теспо-RAP"

Код	ØD1	ØD2	ØC	ØB	L	
T030400	4	4	3,0	9,5	32,0	50
T030406	4	6	3,0	9,5	33,5	50
T030600	6	6	5,0	11,5	35,6	50
T030608	6	8	5,0	11,5	36	50
T030800	8	8	7,0	13,5	38	25
T030810	8	10	7,0	13,5	32,5	50
T031000	10	10	9,0	17,0	42,3	50
T031012	10	12	9,0	17,0	44	50
T031200	12	12	10,0	20,0	46,2	25

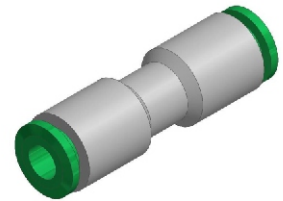
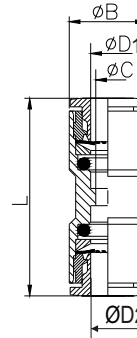

**Артикул 04**

Уголок цанговый

Никелированная латунь; серия "RAP"

Код	ØD	ØC	ØB	L	
040400	4	4,0	10,0	17,3	50
040600	6	5,0	11,0	20,6	50
040800	8	7,0	13,0	23,0	50
041000	10	8,0	16,0	26,4	50
041200	12	10,0	19,0	28,9	25
041400	14	12,0	21,0	31,5	25

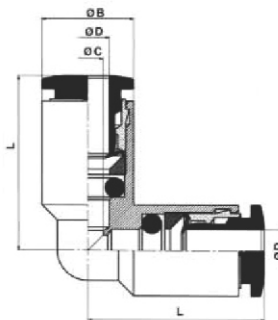

**Артикул T04**

Уголок цанговый

Технополимер; серия "Теспо-RAP"

Код	ØD	ØC	ØB	ØE	L	
T040400	4	3,0	9,5	3,2	17,2	50
T040600	6	5,0	11,5	3,2	20,8	50
T040800	8	7,0	13,5	3,2	23,0	50
T041000	10	9,0	17,0	4,3	26,4	50
T041200	12	10,0	20,0	4,2	28,9	25

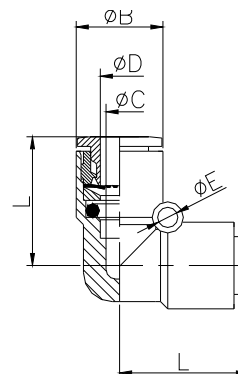

**Артикул T04L0**  
**Уголок цанговый**  
Технополимер; серия "Теспо-RAP"

Код	ØD	ØA	ØC	ØB	L	L1	L2	▲
T0404L0	4	4	3,0	9,5	17,2	20,8	16,7	50
T0406L0	6	6	5,0	11,5	20,8	24,3	19,5	50
T0408L0	8	8	7,0	13,5	23,0	27,3	21,0	50
T0410L0	10	10	9,0	17,0	26,4	31,8	24,0	50
T0412L0	12	12	10,0	20,0	28,9	36,0	25,0	25

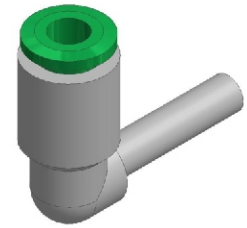
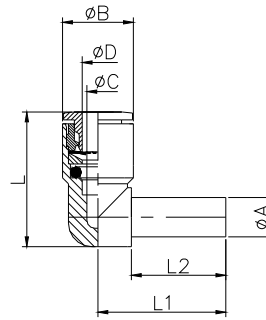

**Артикул 05**  
**Тройник цанговый**  
Никелированная латунь; серия "RAP"

Код	ØD	ØC	ØB	L	▲
050400	4	3,0	9,0	17,3	50
050600	6	5,0	11,0	20,6	50
050800	8	7,0	13,0	23,0	50
051000	10	8,0	16,0	26,4	25
051200	12	10,0	19,0	28,9	25
051400	14	12,0	21,0	31,5	25

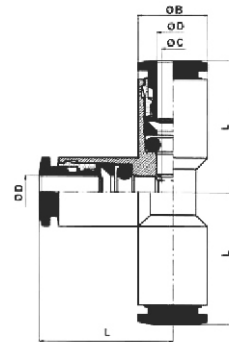

**Артикул T05**  
**Тройник цанговый**  
Технополимер; серия "Теспо-RAP"

Код	ØD	ØD1	ØC	ØB	ØE	L	▲
T050400	4	4	3,0	9,5	3,2	17,2	50
T050600	6	6	5,0	13	3,2	20,8	50
T050604	6	4	5,3	11,5	3,2	19,2	50
T050800	8	8	7,0	14,4	3,2	23,0	50
T050806	8	6	7,1	13,5	3,2	22,7	50
T051000	10	10	8,0	18,4	4,3	26,4	25
T051008	10	8	9,0	17,0	4,3	27,9	25
T051200	12	12	10,0	21,0	4,3	28,9	25
T051210	12	10	10,0	20,0	4,3	29,9	25

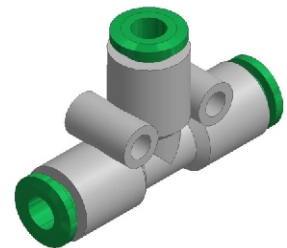
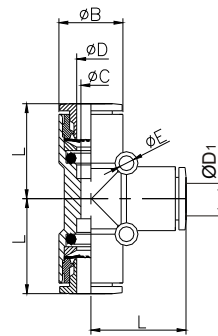

**Артикул T05L0**  
**Тройник цанговый**  
Технополимер; серия "Теспо-RAP"

Код	ØD	ØA	ØC	ØB	L	L1	L2	▲
T0504L0	4	4	3,0	9,5	17,2	20,8	16,7	50
T0506L0	6	6	5,0	11,5	20,8	24,3	19,5	50
T0508L0	8	8	7,0	13,5	23,0	27,3	21,0	50
T0510L0	10	10	9,0	17,0	26,4	31,8	24,0	50
T0512L0	12	12	10,0	20,0	28,9	36,0	25,0	25

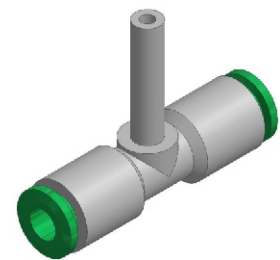
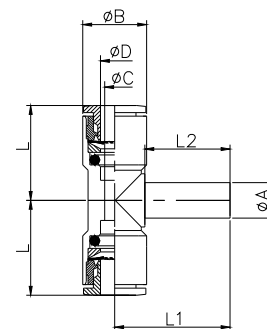

**Артикул T05V0**  
**Тройник цанговый**  
Технополимер; серия "Теспо-RAP"

Код	ØD	ØA	ØC	ØB	L	L1	L2	▲
T0504V0	4	4	3,0	9,5	17,2	20,8	16,7	50
T0506V0	6	6	5,0	11,5	20,8	24,3	19,5	50
T0508V0	8	8	7,0	13,5	23,0	27,3	21,0	50
T0510V0	10	10	8,0	17,0	26,4	31,8	24,0	50
T0512V0	12	12	10,0	20,0	28,9	36,0	25,0	25

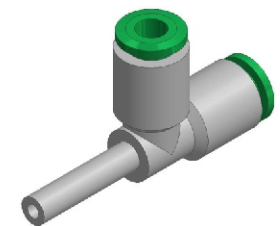
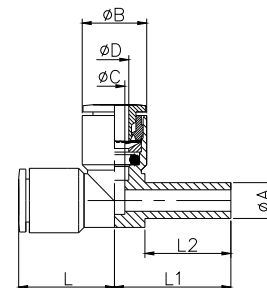

**Артикул 06**

**Штуцер под цанговый фитинг**

Никелированная латунь; серия "RAP"

Код	ØD	G	ØC	ØB	H	L	ØA		
0604M5	4	M5	2,0	8,0	4,0	24,7	2,0	8	50
060418	4	G1/8"	2,0	13,0	6,0	28,2	6,0	13	50
060414	4	G1/4"	2,0	16,0	8,0	30,7	7,5	13	50
0606M5	6	M5	2,6	8,0	4,0	27,5	2,6	8	50
060618	6	G1/8"	4,0	13,0	6,0	21,0	6,0	13	50
060614	6	G1/4"	4,0	16,0	8,0	33,5	7,5	13	50
060818	8	G1/8"	6,0	13,0	6,0	32,5	6,0	13	50
060814	8	G1/4"	6,0	16,0	8,0	33,0	7,5	13	50
060838	8	G3/8"	6,0	20,0	9,0	37,0	9,0	13	50
061018	10	G1/8"	6,0	13,0	6,0	35,5	6,0	13	50
061014	10	G1/4"	8,0	16,0	8,0	38,0	8,0	13	50
061038	10	G3/8"	8,0	20,0	9,0	41,0	8,0	13	50
061214	12	G1/4"	8,0	16,0	8,0	39,0	8,0	13	25
061238	12	G3/8"	10,0	20,0	9,0	42,0	11,0	13	25
061212	12	G1/2"	10,0	24,0	11,0	44,0	13,0	16	25
061438	14	G3/8"	12,0	20,0	9,0	44,5	12,0	16	25
061412	14	G1/2"	12,0	24,0	11,0	46,5	13,0	16	25

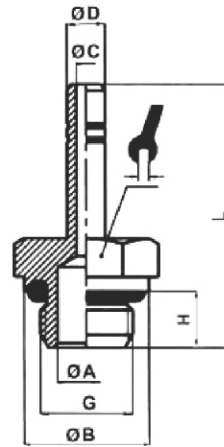

**Артикул 06F**

**Штуцер под цанговый фитинг**

Никелированная латунь; серия "RAP"

Код	ØD	G	ØC	B	H	L		
06F0418	4	G1/8"	2,0	7,0	16,7	29,7	12	50
06F0618	6	G1/8"	4,0	7,0	19,5	32,5	12	50
06F0614	6	G1/4"	4,0	8,0	19,5	35,5	17	50
06F0814	8	G1/4"	6,0	8,0	21,0	37,0	17	50

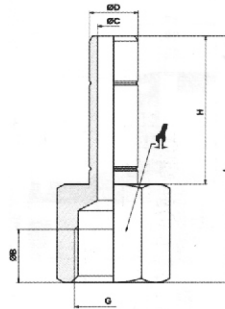

**Артикул 60**

**Штуцер высокий под цанговый фитинг**

Никелированная латунь; серия "RAP"

Код	ØD	G	ØC	ØB	H	L	ØA		
600418	4	G1/8"	2,0	13,0	6,0	39,7	6,0	13	50
600618	6	G1/8"	4,0	13,0	6,0	45,0	6,0	13	50
600614	6	G1/4"	4,0	16,0	8,0	47,5	7,5	13	50
600818	8	G1/8"	6,0	13,0	6,0	48,5	6,0	13	50
600814	8	G1/4"	6,0	16,0	8,0	51,0	7,5	13	50
600838	8	G3/8"	6,0	20,0	9,0	51,5	9,0	13	50
601014	10	G1/4"	8,0	16,0	8,0	55,5	7,5	13	50
601038	10	G3/8"	8,0	13,0	9,0	57,5	9,0	13	25

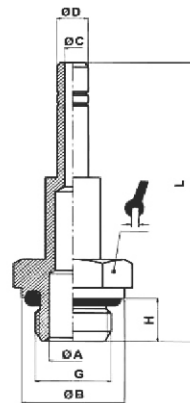

**Артикул 07**

**Соединитель цанговых фитингов**

Никелированная латунь; серия "RAP"

Код	ØD	ØC	L	
070400	4	2,0	32,0	100
070600	6	4,0	39,0	50
070800	8	6,0	42,0	50
071000	10	8,0	48,0	50
071200	12	10,0	50,0	25
071400	14	12,0	53,0	25

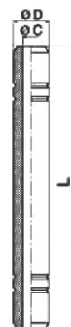

1

1

**Артикул 08**

**Фитинг-переходник цанговый**

Никелированная латунь; серия "RAP"

Код	ØD1	ØD2		ØB	L	▲
080604	6	4		9,0	32,5	50
080804	8	4		9,0	34,0	50
080806	8	6		11,0	36,0	50
081006	10	6		11,0	39,3	50
081008	10	8		13,0	39,0	50
081204	12	4		13,0	40,0	25
081206	12	6		13,0	40,3	25
081208	12	8		13,0	39,5	25
081210	12	10		16,0	41,4	25
081404	14	4		15,0	43,5	25
081406	14	6		15,0	43,8	25
081408	14	8		15,0	44,0	25
081410	14	10		16,0	43,9	25
081412	14	12		19,0	45,9	25

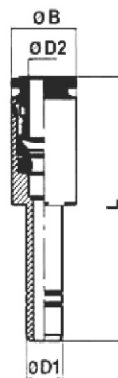

**Артикул T08**

**Фитинг-переходник цанговый**

Технополимер; серия "Теспо-RAP"

Код	ØD1	ØD	ØB	L	L1	▲
T080604	6	4	9,5	35,5	19,5	50
T080804	8	4	9,5	37,0	21,0	50
T081004	10	4	9,5	40,0	24,0	50
T081204	12	4	9,5	41,0	25,0	50
T080806	8	6	11,5	39,05	23,0	50
T081006	10	6	11,5	42,05	24,0	50
T081206	12	6	11,5	43,05	25,0	50
T081008	10	8	13,5	43,0	26,25	50
T081208	12	8	13,5	44,0	25,0	50
T081210	12	10	17,0	46,15	27,55	25

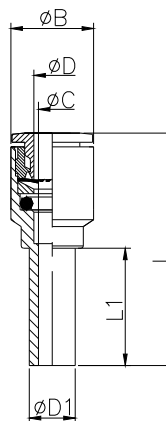

**Артикул 08/E**

**Фитинг-переходник цанговый**

Никелированная латунь; Серия "RAP"

Код	ØD1	ØD2		ØB	L	▲
08E0406	4	6		11,0	35,5	50
08E0608	6	8		13,0	39,0	50



**Артикул 09**

**Заглушка в цанговый фитинг**

Никелированная латунь; Серия "RAP"

Код	ØD	ØB		L	▲
090400	4	5,0		26,0	50
090600	6	7,0		29,0	50
090800	8	9,0		31,5	50
091000	10	11,0		35,0	50
091200	12	13,0		37,0	25
091400	14	15,0		39,5	25

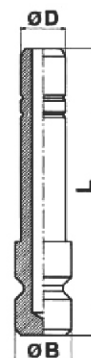

**Артикул T09**  
**Заглушка в цанговый фитинг**  
Технополимер; Серия "Теспо-RAP"

Код	ØD	ØB			L	
T090400	4	7,0			25,0	50
T090600	6	9,5			27,5	50
T090800	8	12,0			30,0	50
T091000	10	14,0			32,5	50
T091200	12	16,0			35,0	25

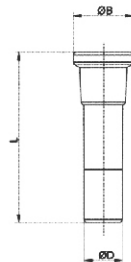

**Артикул 10**  
**Фитинг-соединитель с монтажными гайками**  
Никелированная латунь; Серия "RAP"

Код	ØD	ØC	M	l <sub>MAX</sub>	L		
100400	4	3,0	M11x1	8,0	32,0	14	50
100600	6	5,0	M14x1	8,0	36,1	17	50
100800	8	7,0	M16x1	10,0	38,0	18	50
101000	10	9,0	M18x1	12,0	42,3	21	25
101200	12	11,0	M22x1	17,0	45,8	20	25
101400	14	13,0	M24x1	18,0	47,5	27	25

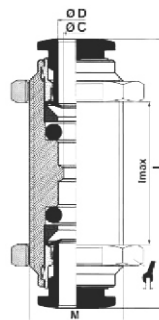

**Артикул T10**  
**Фитинг-соединитель с монтажными гайками**  
Технополимер; Серия "Теспо-RAP"  
(монтажные гайки из никелированной латуни)

Код	ØD	ØC	M	l <sub>MAX</sub>	L		
T100400	4	3,0	M11x1	8,0	32,0	14	50
T100600	6	5,0	M14x1	8,0	36,1	17	50
T100800	8	7,0	M16x1	10,0	38,0	18	50
T101000	10	9,0	M20x1	12,0	42,3	24	50
T101200	12	10,0	M22x1	17,0	46,2	20	50

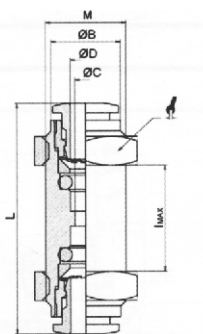

**Артикул T10L**  
**Фитинг-соединитель угловой с монтажными гайками**  
Технополимер; Серия "Теспо-RAP"  
(монтажные гайки из никелированной латуни)

Код	ØD	B	M	E		
T10L0400	4	28,5	M12x1	19,0	14	50
T10L0600	6	32,1	M14x1	19,2	17	50
T10L0800	8	39,4	M16x1	23,0	19	50
T10L1000	10	44,8	M20x1	28,2	24	50
T10L1200	12	46,6	M22x1	29,5	27	50

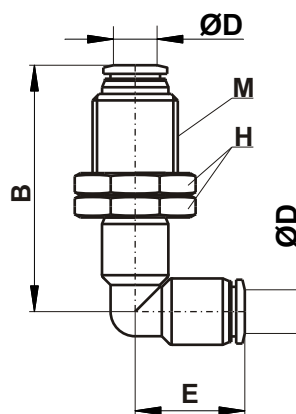

**Артикул 25**  
**Фитинг цанговый с внутренней резьбой и монтажной гайкой**  
Никелированная латунь; Серия "RAP"

Код	ØA	ØB	C	D	E	L		
250418	4	M10	G1/8"	15,5	6,5	25,5	15	25
250618	6	M14	G1/8"	15,8	6,5	26,8	15	25
250614	6	M14	G1/4"	15,8	10	31,3	17	25
250818	8	M16	G1/8"	16	6,5	29	17	25
250814	8	M16	G1/4"	16	10	33,5	17	25

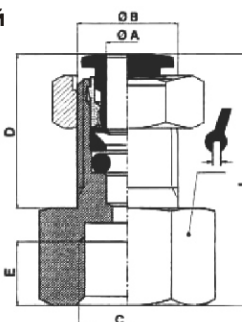



Цанговые фитинги серий "RAP" и "Теспо-RAP".  
Резьбы М5 - G1/2". Трубки 4 - 14 мм.



**Артикул 13**

**Фитинг-серьга под пустотелый болт или дроссель**

Никелированная латунь; серия "RAP"

Код	ØD	Болт	ØA	ØB	H	L	
1304M5	4	M5	5,0	8,0	9,0	19,5	50
130418	4	G1/8"	9,9	14,0	15,0	21,1	50
130618	6	G1/8"	9,9	14,0	15,0	24,3	50
130614	6	G1/4"	13,3	18,0	17,0	25,5	50
130638	6	G3/8"	16,75	21,0	20,0	28,0	25
130818	8	G1/8"	9,9	14,0	15,0	24,8	50
130814	8	G1/4"	13,3	18,0	17,0	26,5	50
130838	8	G3/8"	16,75	21,0	20,0	28,0	50
131014	10	G1/4"	13,3	18,0	17,0	28,4	50
131038	10	G3/8"	16,75	21,0	20,0	29,9	25
131214	12	G1/4"	13,3	18	17	30,9	25
131238	12	G3/8"	16,75	21,0	20,0	31,4	25
131212	12	G1/2"	21,0	26,0	24,0	34,9	25
131412	14	G1/2"	21,0	26,0	24,0	35,5	25

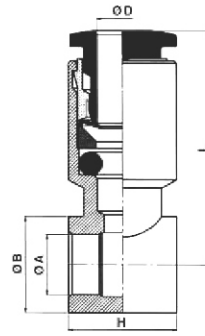

Совместимы с болтами моделей 33А, 34А, 407, 408, и дросселями моделей 28А, 29А, 30А.

**Артикул T13**

**Фитинг-серьга под пустотелый болт или дроссель**

Технополимер; серия "Теспо-RAP"

Код	ØD	Болт	ØE	ØF	H	L	
T1304M5	4	M5	5,0	8,0	10,0	19,5	50
T130418	4	G1/8"	9,9	14,0	15,0	21,1	50
T130618	6	G1/8"	9,9	14,0	15,0	24,3	50
T130614	6	G1/4"	13,3	18,0	17,0	25,5	50
T130818	8	G1/8"	9,9	14,0	15,0	24,8	50
T130814	8	G1/4"	13,3	18,0	17,0	26,5	50
T130838	8	G3/8"	16,75	21,3	20,0	28,0	50
T131014	10	G1/4"	13,3	18,0	17,0	28,4	50
T131038	10	G3/8"	16,75	21,3	20,0	29,9	25
T131012	10	G1/2"	21,0	26,0	24,0	30,0	25
T131238	12	G3/8"	16,75	21,3	20,0	31,4	25
T131212	12	G1/2"	21,0	26,0	24,0	34,9	25

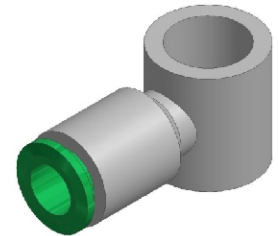
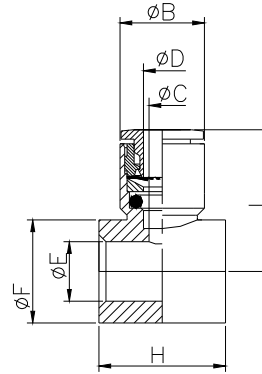

Совместимы с болтами моделей 33А, 34А, 407, 408, и дросселями моделей 28А, 29А, 30А.

**Артикул T13B**

**Фитинг-серьга двойная под пустотелый болт или дроссель**

Технополимер; серия "Теспо-RAP"

Код	ØD	Болт	H	L	L2	
T13B04M5	4	M5	10,0	19,5	19,0	50
T13B0618	6	G1/8"	15,0	24,3	23,0	50
T13B0814	8	G1/4"	17,0	26,5	27,0	50
T13B1038	10	G3/8"	20,0	29,9	34,0	25
T13B1212	12	G1/2"	24,0	34,9	40,0	10

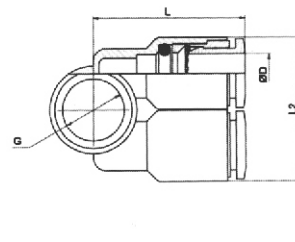

Совместимы с болтами моделей 33А, 34А, 407, 408, и дросселями моделей 28А, 29А, 30А.

**Артикул 14**

**Фитинг-серьга двухсторонняя под пустотелый болт, дроссель**

Никелированная латунь; серия "RAP"

Код	ØD	Болт	ØA	ØB	H	L	
1404M5	4	M5	5,0	8,0	9,0	19,5	50
140418	4	G1/8"	9,9	14,0	15,0	21,1	50
140618	6	G1/8"	9,9	14,0	15,0	24,3	50
140614	6	G1/4"	13,3	18,0	17,0	25,5	50
140818	8	G1/8"	9,9	14,0	15,0	24,8	50
140814	8	G1/4"	13,3	18,0	17,0	26,5	50
140838	8	G3/8"	16,75	21,0	20,0	28,0	50
141014	10	G1/4"	13,3	18,0	17,0	28,4	50
141038	10	G3/8"	16,75	21,0	20,0	29,9	25

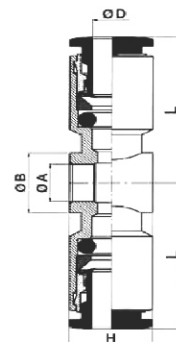

Совместимы с болтами моделей 33А, 34А, 407, 408, и дросселями моделей 28А, 29А, 30А.



**Артикул Т14**

**Фитинг-серьга двухсторонняя под пустотелый болт, дроссель**  
Технополимер; серия "Теспо-RAP"

Код	ØD	Болт	ØE	ØF	H	L	⌀	▾
T1404M5	4	M5	5,0	8,0	10,0	19,5	50	
T140418	4	G1/8"	9,9	14,0	15,0	21,1	50	
T140618	6	G1/8"	9,9	14,0	15,0	24,3	50	
T140614	6	G1/4"	13,3	18,0	17,0	25,5	50	
T140818	8	G1/8"	9,9	14,0	15,0	24,8	50	
T140814	8	G1/4"	13,3	18,0	17,0	26,5	50	
T140838	8	G3/8"	16,75	21,3	20,0	28,0	50	
T141014	10	G1/4"	13,3	18,0	17,0	28,4	50	
T141038	10	G3/8"	16,75	21,3	20,0	29,9	25	
T141012	10	G1/2"	21,0	26,0	24,0	30,0	25	
T141238	12	G3/8"	16,75	21,3	20,0	31,4	25	
T141212	12	G1/2"	21,0	26,0	24,0	34,9	25	

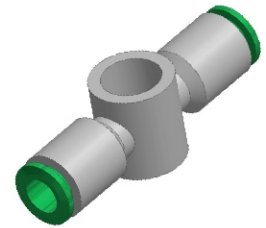
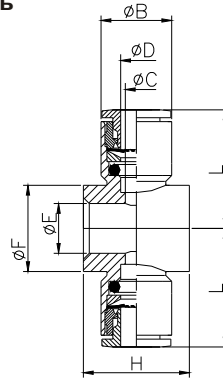

Совместимы с болтами моделей 33А, 34А, 407, 408, и дросселями моделей 28А, 29А, 30А.

**Артикул 15**

**Фитинг цанговый угловой поворотный**  
Никелированная латунь; Серия "RAP"

Код	ØD	G	ØA	H	L <sub>1</sub>	L	⌀	▾
1504M5	4	M5	2,0	4,0	16,8	19,5	2,5	50
1504M6	4	M6	2,0	4,0	16,8	19,5	2,5	50
150418	4	G1/8"	5,5	6,0	25,0	21,1	3,0	50
1506M5	6	M5	2,0	4,0	16,5	22,0	2,5	50
150618	6	G1/8"	5,5	6,0	25,0	24,3	3,0	50
150614	6	G1/4"	7,8	8,0	29,5	25,5	4,0	50
150638	6	G3/8"	7,8	9,0	34,0	28,0	5,0	25
150818	8	G1/8"	5,5	6,0	25,0	24,8	3,0	50
150814	8	G1/4"	7,8	8,0	29,3	26,5	4,0	50
150838	8	G3/8"	10,0	9,0	34,0	28,0	5,0	25
151014	10	G1/4"	7,8	8,0	29,3	28,4	4,0	25
151038	10	G3/8"	10,0	9,0	34,0	29,9	5,0	25
151214	12	G1/4"	7,8	8,0	29,3	30,9	4,0	25
151238	12	G3/8"	10,0	9,0	34,0	31,4	5,0	25
151212	12	G1/2"	12,0	11,0	40,8	34,9	8,0	20
151412	14	G1/2"	12,0	11,0	40,8	35,5	8,0	20

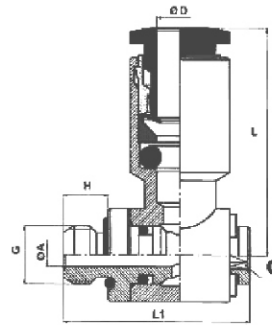

**Артикул Т15**

**Фитинг цанговый угловой поворотный**  
Технополимер; Серия "Теспо-RAP"  
(пустотелый болт из никелированной латуни)

Код	ØD	G	ØA	H	L <sub>1</sub>	L	⌀	▾
T1504M5	4	M5	2,0	4,0	17,8	19,5	2,5	50
T150418	4	G1/8"	5,5	5,5	24,5	21,1	3,0	50
T150618	6	G1/8"	5,5	5,5	24,5	24,3	3,0	50
T150614	6	G1/4"	7,8	6,5	28,0	25,5	4,0	50
T150818	8	G1/8"	5,5	5,5	24,5	24,8	3,0	50
T150814	8	G1/4"	7,8	6,5	28,0	26,5	4,0	50
T150838	8	G3/8"	10,0	7,5	32,5	28,0	5,0	25
T151014	10	G1/4"	7,8	6,5	28,0	28,4	4,0	25
T151038	10	G3/8"	10,0	7,5	32,5	29,9	5,0	25
T151012	10	G1/2"	12,0	9,0	38,8	30,0	8,0	25
T151238	12	G3/8"	10,0	7,5	32,5	31,4	5,0	25
T151212	12	G1/2"	12,0	9,0	38,8	34,9	8,0	25

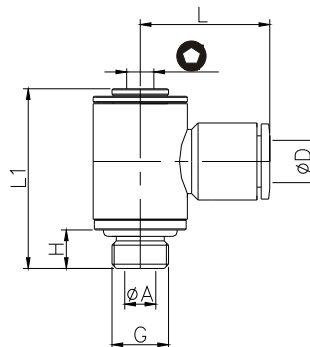



Цанговые фитинги серий "RAP" и "Теспо-RAP".  
Резьбы M5 - G1/2". Трубки 4 - 14 мм.



**Артикул T15FC**

**Фитинг проходной с поворотным цанговым отводом**  
Технополимер; Серия "Теспо-RAP"  
(пустотелый болт из никелированной латуни)

Код	ØD	R	RC	ØK	A1	L1	B	⚙	📏
T15FC0418	4	R1/8"	G1/8"	14,4	7,5	23,5	29,0	14	50
T15FC0618	6	R1/8"	G1/8"	14,4	7,5	24,0	29,0	14	50
T15FC0614	6	R1/4"	G1/4"	18,3	9,5	25,4	35,0	17	50
T15FC0818	8	R1/8"	G1/8"	14,4	7,5	28,9	29,0	14	50
T15FC0814	8	R1/4"	G1/4"	18,3	9,5	29,1	35,0	17	50
T15FC0838	8	R3/8"	G3/8"	22,0	10,5	30,0	40,0	21	25
T15FC1014	10	R1/4"	G1/4"	22,0	10,5	33,0	40,0	21	25
T15FC1038	10	R3/8"	G3/8"	28,0	13,5	33,5	47,5	24	25
T15FC1012	10	R1/2"	G1/2"	18,3	9,5	36,5	35,0	17	25
T15FC1238	12	R3/8"	G3/8"	22,0	10,5	35,8	40,0	21	25
T15FC1212	12	R1/2"	G1/2"	28,0	13,5	36,8	47,5	24	25

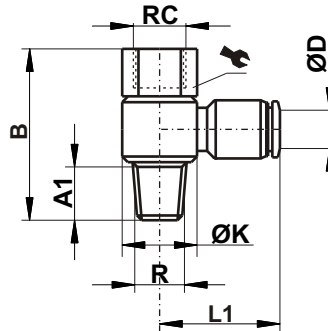

**Артикул T15B**

**Фитинг цанговый двойной угловой поворотный**  
Технополимер; Серия "Теспо-RAP"  
(пустотелый болт из никелированной латуни)

Код	ØD	G	ØA	H	L1	L	⚙	📏
T15B04M5	4	M5	2,0	4,0	17,8	19,5	2,5	50
T15B0618	6	G1/8"	5,5	5,5	24,5	24,3	3,0	50
T15B0814	8	G1/4"	7,8	6,5	28,0	26,5	4,0	50
T15B1038	10	G3/8"	10,0	7,5	32,5	29,9	5,0	25
T15B1212	12	G1/2"	12,0	9,0	38,8	34,9	8,0	10

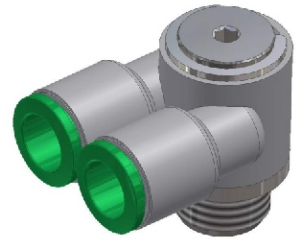
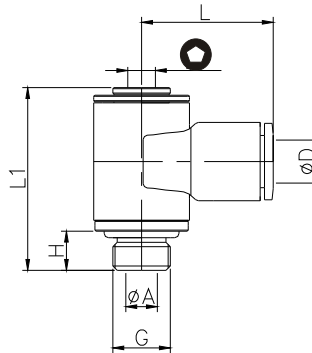

**Артикул 16**

**Фитинг цанговый двойной угловой поворотный**  
Никелированная латунь; Серия "RAP"

Код	ØD	G	ØA	H	L1	L	⚙	📏
1604M5	4	M5	2,0	4,0	16,8	19,5	2,0	50
160418	4	G1/8"	5,5	6,0	25,0	21,1	3,0	50
160618	6	G1/8"	5,5	6,0	25,0	24,3	3,0	50
160614	6	G1/4"	7,8	8,0	29,3	25,5	4,0	50
160818	8	G1/8"	5,5	6,0	25,0	24,8	3,0	50
160814	8	G1/4"	7,8	8,0	29,3	26,5	4,0	25
160838	8	G3/8"	10,0	9,0	34,0	28,0	5,0	25
161014	10	G1/4"	7,8	8,0	29,3	28,4	4,0	25
161038	10	G3/8"	10,0	9,0	34,0	29,9	5,0	25

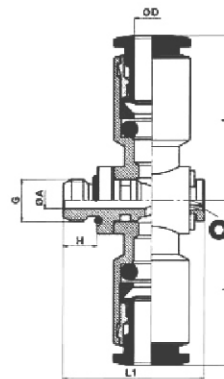

**Артикул T16**

**Фитинг цанговый двойной угловой поворотный**  
Технополимер; Серия "Теспо-RAP"  
(пустотелый болт из никелированной латуни)

Код	ØD	G	ØA	H	L1	L	⚙	📏
T1604M5	4	M5	2,0	4,0	17,8	19,5	2,5	50
T160418	4	G1/8"	5,5	5,5	24,5	21,1	3,0	50
T160618	6	G1/8"	5,5	5,5	24,5	24,3	3,0	50
T160614	6	G1/4"	7,8	6,5	28,0	25,5	4,0	50
T160818	8	G1/8"	5,5	5,5	24,5	24,8	3,0	50
T160814	8	G1/4"	7,8	6,5	28,0	26,5	4,0	25
T160838	8	G3/8"	10,0	7,5	32,5	28,0	5,0	25
T161014	10	G1/4"	7,8	6,5	28,0	28,4	4,0	25
T161038	10	G3/8"	10,0	7,5	32,5	29,9	5,0	25
T161012	10	G1/2"	12,0	9,0	38,8	30,0	8,0	10
T161238	12	G3/8"	10,0	7,5	32,5	31,4	5,0	25
T161212	12	G1/2"	12,0	9,0	38,8	34,9	8,0	10

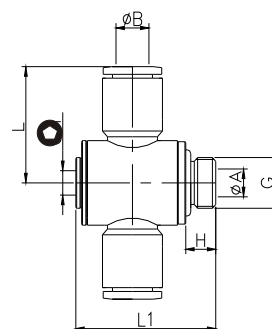

1

1

**Артикул Т18**

**Коллектор цанговый**

Технополимер; Серия "Теспо-RAP"

Код	ØD	ØD1	J	B	Ød	F2	
T180604	6	4	26	62,4	3,2	43	25
T180804	8	4	26	63,4	3,2	43	20
T180806	8	6	26	63,4	3,2	43	20
T181006	10	6	29	83,8	4,2	48	10
T181008	10	8	29	83,8	4,2	48	10

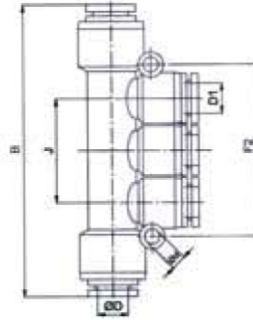

**Артикул Т18G**

**Коллектор цанговый**

Технополимер; Серия "Теспо-RAP"

Код	ØD; D1	G	A	B	J	H	Ød	
T18G0418	4	G1/8"	7,5	64	22	10	3,2	25
T18G0414	4	G1/4"	9,5	67	22	14	3,2	25
T18G0438	4	G3/8"	10,5	68,5	22	17	3,2	10
T18G0618	6	G1/8"	13,5	68,7	22	12	3,2	25
T18G0614	6	G1/4"	9,5	71,2	26	14	3,2	25
T18G0638	6	G3/8"	10,5	72,7	26	17	3,2	10
T18G0612	6	G1/2"	13,5	76,2	26	21	3,2	10
T18G0818	8	G1/8"	7,5	88,5	29	14	3,2	20
T18G0814	8	G1/4"	9,5	90,5	29	14	3,2	20
T18G0838	8	G3/8"	10,5	92,2	29	17	3,2	10
T18G0812	8	G1/2"	13,5	96,2	29	21	3,2	10
T18G1018	10	G1/8"	7,5	89,9	29	17	4,2	10
T18G1014	10	G1/4"	9,5	91,9	29	17	4,2	10
T18G1038	10	G3/8"	10,5	92,9	29	17	4,2	10
T18G1012	10	G1/2"	13,5	96,4	29	21	4,2	10

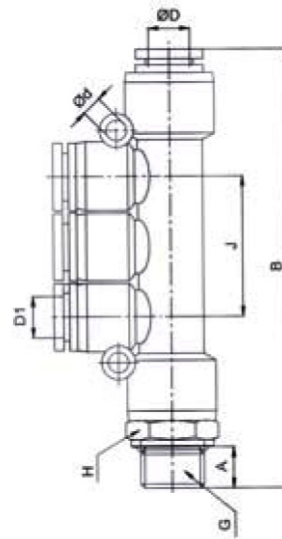

**Артикул 20**

**Фитинг-тройник цанговый поворотный, тип "Т"**

Никелированная латунь; серия "RAP"

Код	ØD	A	ØB	L1	L2		
2004M5	4	M5	9,0	17,3	20,0	8	50
200418	4	G1/8"	11,0	17,3	18,5	13	50
200414	4	G1/4"	9,0	19,0	22,5	16	50
200618	6	G1/8"	11,0	20,6	18,5	13	50
200614	6	G1/4"	11,0	22,1	22,5	16	50
200818	8	G1/8"	13,0	23,0	20,5	13	50
200814	8	G1/4"	13,0	23,0	22,5	16	50
200838	8	G3/8"	13,0	24,5	25,5	18	25
201014	10	G1/4"	16,0	26,4	24,5	16	25
201038	10	G3/8"	16,0	26,4	25,5	18	25

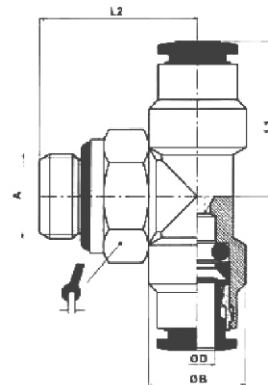

**Артикул 21**

**Фитинг-тройник цанговый поворотный, тип "L"**

Никелированная латунь; Серия "RAP"

Код	ØD	A	ØB	L	L2		
2104M5	4	M5	9,0	17,3	20,0	8	50
210418	4	G1/8"	9,0	17,3	18,5	13	50
210414	4	G1/4"	9,0	19,0	22,5	16	50
210618	6	G1/8"	11,0	20,6	18,5	13	50
210614	6	G1/4"	11,0	22,1	22,5	16	50
210818	8	G1/8"	13,0	23,0	20,5	13	50
210814	8	G1/4"	13,0	23,0	22,5	16	50
210838	8	G3/8"	13,0	24,5	25,5	18	50
211014	10	G1/4"	16,0	26,4	24,5	16	25
211038	10	G3/8"	16,0	26,4	25,5	18	25

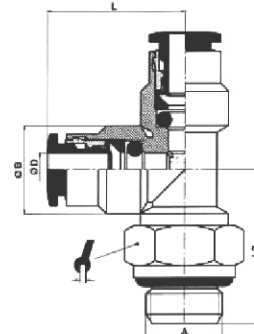



### Артикул Т20

#### Фитинг-тройник цанговый поворотный, тип "Т"

Технополимер; Серия "Теспо-RAP"

(пустотельный болт из никелированной латуни)

Код	ØD	A	ØB	L <sub>1</sub>	L		
T204M5	4	M5	9,5	17,0	17,2	8	50
T200418	4	G1/8"	9,5	18,5	17,2	13	50
T200414	4	G1/4"	9,5	20,4	17,2	16	50
T200438	4	G3/8"	11,0	27,3	19,0	20	25
T2006M5	6	M5	9,5	17,0	20,8	8	50
T200618	6	G1/8"	11,5	18,5	20,8	13	50
T200614	6	G1/4"	11,5	20,4	20,8	16	50
T200638	6	G3/8"	13,0	27,5	19,7	20	25
T200612	6	G1/2"	13,0	30,0	19,7	24	10
T200818	8	G1/8"	13,5	20,0	23,0	13	50
T200814	8	G1/4"	13,5	20,4	23,0	16	50
T200838	8	G3/8"	13,5	24,8	23,0	18	25
T200812	8	G1/2"	14,4	32,5	23,7	24	10
T201018	10	G1/8"	18,4	33,5	28,6	17	25
T201014	10	G1/4"	17,0	23,2	26,4	16	25
T201038	10	G3/8"	17,0	24,8	26,4	18	25
T201012	10	G1/2"	17,0	31,1	26,4	21	10
T201218	12	G1/8"	21,0	33,5	29,8	27	20
T201214	12	G1/4"	20,0	24,2	28,9	16	25
T201238	12	G3/8"	20,0	26,3	28,9	18	25
T201212	12	G1/2"	9,0	1/2	31,1	21	10

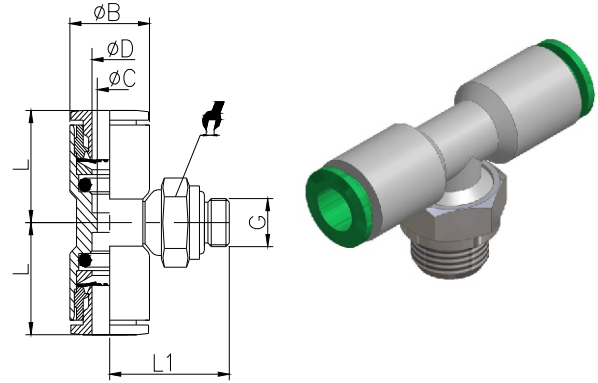



### Артикул Т21

#### Фитинг-тройник цанговый поворотный, тип "L"

Технополимер; Серия "Теспо-RAP"

(пустотельный болт из никелированной латуни)

Код	ØD	G	ØB	L	L <sub>1</sub>		
T2104M5	4	M5	9,5	12,2	17,0	8	50
T210418	4	G1/8"	9,5	17,2	18,5	13	50
T210414	4	G1/4"	9,5	17,2	20,4	16	50
T210438	4	G3/8"	11,0	19,0	27,3	20	25
T2106M5	6	M5	9,5	20,8	17,0	8	50
T210618	6	G1/8"	11,5	20,8	18,5	13	50
T210614	6	G1/4"	11,5	20,8	20,4	16	50
T210638	6	G3/8"	13,0	19,7	27,5	20	25
T210612	6	G1/2"	13,0	19,7	30,0	24	10
T210818	8	G1/8"	13,5	23,0	20,0	13	50
T210814	8	G1/4"	13,5	23,0	20,4	16	50
T210838	8	G3/8"	13,5	23,0	24,8	18	25
T210812	8	G1/2"	14,4	23,7	32,5	24	10
T211018	10	G1/8"	18,4	28,9	32,5	17	25
T211014	10	G1/4"	17,0	26,4	23,2	16	25
T211038	10	G3/8"	17,0	26,4	24,8	18	25
T211012	10	G1/2"	17,0	26,4	31,1	21	10
T211218	12	G1/8"	21,0	29,8	33,5	21	25
T211214	12	G1/4"	20,0	28,9	24,2	16	25
T211238	12	G3/8"	20,0	28,9	26,3	18	25
T211212	12	G1/2"	20,0	28,9	31,1	21	10

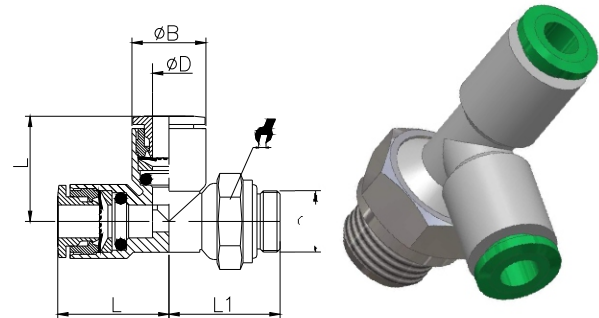

**Артикул RGR**  
**Фитинг цанговый угловой поворотный**  
Никелированная латунь; Серия "RAP"

Код	ØD	G	ØA	H	L	L1	⊙	▢
RGR3.20	2	M3	1,4	3,0	13,0	13,5	1,5	50
RGR3.30	3	M3	1,4	3,0	13,5	13,5	1,5	50
RGR5.20	2	M5	2,0	3,5	13,0	14,0	1,5	50
RGR5.30	3	M5	2,0	3,5	13,5	14,0	2,0	50
RGR5.40	4	M5	2,0	3,5	14,5	14,0	2,0	50

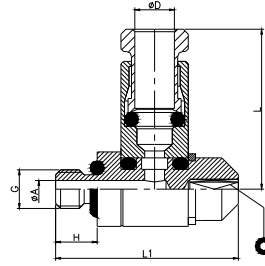

**Артикул 19**  
**Фитинг цанговый угловой**  
Никелированная латунь; Серия "RAP"

Код	ØD	G	ØB	E	L	⊙	▢
190418	4,0	R1/8"	9,0	18,6	16,5	10	100
190618	6,0	R1/8"	11,0	23,8	16,5	10	100
190614	6,0	R1/4"	11,0	25,3	22,5	11	100
190818	8,0	R1/8"	13,0	25,5	18,5	11	100
190814	8,0	R1/4"	13,0	25,5	22,0	11	100

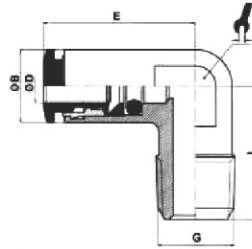

**Артикул 22**  
**Фитинг цанговый угловой поворотный**  
Никелированная латунь; Серия "RAP"

Код	ØD	G	ØB	L1	L2	⊙	▢
2204M5	4	M5	9,0	17,3	20,0	8	100
220418	4	G1/8"	11,0	17,3	18,5	13	100
220414	4	G1/4"	9,0	19,0	22,5	16	100
2206M5	6	M5	11,0	20,0	20,6	8	100
220618	6	G1/8"	11,0	20,6	18,5	13	100
220614	6	G1/4"	11,0	22,1	22,5	16	100
220818	8	G1/8"	13,0	23,0	20,5	13	100
220814	8	G1/4"	13,0	23,0	22,5	16	100
220838	8	G3/8"	13,0	24,5	25,5	18	50
221014	10	G1/4"	16,0	26,4	24,5	16	50
221038	10	G3/8"	16,0	26,4	25,5	18	50
221012	10	G1/2"	17,0	27,9	29,0	21	50
221214	12	G1/4"	19,0	28,9	24,5	16	50
221238	12	G3/8"	19,0	28,9	24,5	18	50
221212	12	G1/2"	19,0	28,9	31,0	21	25
221438	14	G3/8"	21,0	31,5	28,0	18	25
221412	14	G1/2"	21,0	31,5	33,0	21	25

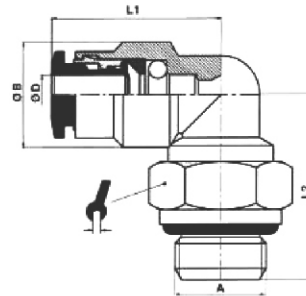

**Артикул T22**  
**Фитинг цанговый угловой поворотный**  
Технополимер; Серия "Теспо-RAP"  
(пустотелый болт из никелированной латуни)

Код	ØD	G	ØB	L	L1	⊙	▢
T2204M5	4	M5	9,5	17,2	17,0	8	100
T220418	4	G1/8"	9,5	17,2	18,5	13	100
T220414	4	G1/4"	9,5	17,2	20,4	16	100
T2206M5	6	M5	11,5	20,8	17,0	8	100
T220618	6	G1/8"	11,5	20,8	18,5	13	100
T220614	6	G1/4"	11,5	20,8	20,4	16	100
T220818	8	G1/8"	13,5	23,0	20,0	13	100
T220814	8	G1/4"	13,5	23,0	20,4	16	100
T220838	8	G3/8"	13,5	23,0	24,8	18	50
T221018	10	G1/8"	17,0	26,4	35,6	13	50
T221014	10	G1/4"	17,0	26,4	23,2	16	50
T221038	10	G3/8"	17,0	26,4	24,8	18	50
T221012	10	G1/2"	17,0	26,4	31,1	21	25
T221214	12	G1/4"	20,0	28,9	24,2	16	50
T221238	12	G3/8"	20,0	28,9	26,3	18	50
T221212	12	G1/2"	20,0	28,9	31,1	21	25

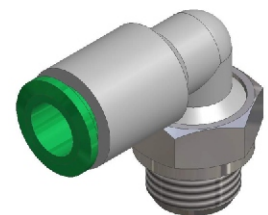
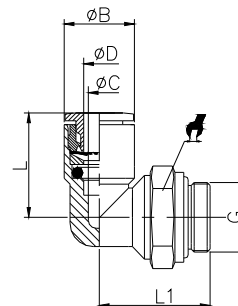

**Артикул T22T**

**Фитинг цанговый угловой поворотный**  
Технополимер; Серия "Теспо-RAP"

Код	ØD	G	ØB	L	L1		
T22T0418	4	G1/8"	9,5	17,2	18,5	13	100
T22T0414	4	G1/4"	9,5	17,2	20,4	16	100
T22T0618	6	G1/8"	11,5	20,8	18,5	13	100
T22T0614	6	G1/4"	11,5	20,8	20,4	16	100
T22T0818	8	G1/8"	13,5	23,0	20,0	13	100
T22T0814	8	G1/4"	13,5	23,0	20,4	16	100
T22T1014	10	G1/4"	17,0	26,4	23,2	16	50

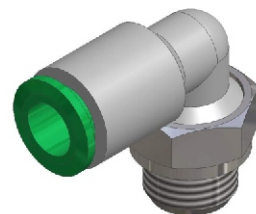
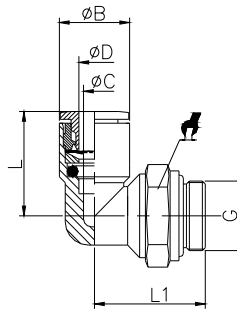

**Артикул T22C**

**Фитинг цанговый угловой поворотный**

Технополимер; Серия "Теспо-RAP"  
(пустотелый болт из никелированной латуни)

Код	ØD	G	ØB	L	L1		
T22C0418	4	R1/8"	9,5	17,2	19,2	13	100
T22C0414	4	R1/4"	9,5	17,2	22,2	14	100
T22C0438	4	R3/8"	11,0	19,0	28,5	20	25
T22C0618	6	R1/8"	11,5	20,8	19,2	13	100
T22C0614	6	R1/4"	11,5	20,8	22,2	14	100
T22C0638	6	R3/8"	13,0	19,2	29,7	17	25
T22C0612	6	R1/2"	13,0	19,2	31,2	24	10
T22C0818	8	R1/8"	13,5	23,0	21,5	13	100
T22C0814	8	R1/4"	13,5	23,0	23,4	14	100
T22C0838	8	R3/8"	13,5	23,0	24,3	17	50
T22C0812	8	R1/2"	14,4	23,0	34,5	24	10
T22C1014	10	R1/4"	17,0	26,4	26,2	14	50
T22C1038	10	R3/8"	17,0	26,4	27,3	17	50
T22C1012	10	R1/2"	17,0	26,4	29,4	22	50
T22C1214	12	R1/4"	20,0	28,9	27,2	14	50
T22C1238	12	R3/8"	20,0	28,9	28,8	17	50
T22C1212	12	R1/2"	20,0	28,9	31,9	22	25

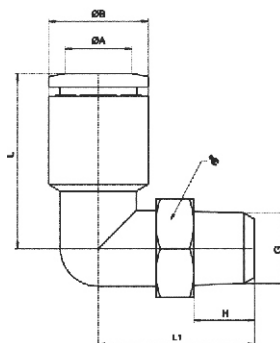

**Артикул T22F**

**Фитинг цанговый угловой поворотный**

Технополимер; Серия "Теспо-RAP"  
(пустотелый болт из никелированной латуни)

Код	ØD	G	A	B	E		
T22F04M5	4	M5	5,5	20,5	19,0	10	50
T22F0418	4	G1/8"	8,5	24,0	19,0	14	50
T22F0414	4	G1/4"	11,0	27,0	19,0	17	50
T22F06M5	6	M5	6,0	20,7	19,2	12	50
T22F0618	6	G1/8"	8,5	24,2	19,2	14	50
T22F0614	6	G1/4"	11,0	27,2	19,2	17	50
T22F0638	6	G3/8"	12,0	28,7	19,2	21	25
T22F0818	8	G1/8"	8,0	27,0	23,0	14	50
T22F0814	8	G1/4"	11,0	30,5	23,0	17	50
T22F0838	8	G3/8"	12,0	32,0	23,0	21	25
T22F1014	10	G1/4"	11,0	34,3	28,2	17	25
T22F1038	10	G3/8"	12,0	35,8	28,2	21	25
T22F1012	10	G1/2"	14,0	38,8	28,2	24	10
T22F1214	12	G1/4"	11,0	37,0	29,5	21	25
T22F1238	12	G3/8"	12,0	38,0	29,5	21	25
T22F1212	12	G1/2"	14,0	40,5	29,5	24	10

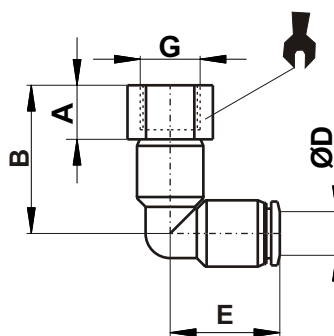

**Артикул T22L**

**Фитинг цанговый угловой высокий поворотный**

Технополимер; Серия "Теспо-RAP"  
(пустотелый болт из никелированной латуни)

Код	ØD	G	ØB	L	L1		
T22L04M5	4	M5	11,0	34,5	19,0	10	25
T22L06M5	6	M5	13,0	36,4	19,2	10	25
T22L0418	4	G1/8"	9,5	35,7	17,2	13	25
T22L0618	6	G1/8"	11,5	35,7	20,8	13	25
T22L0818	8	G1/8"	13,5	38,0	23,0	13	25
T22L0814	8	G1/4"	13,5	43,9	23,0	16	25

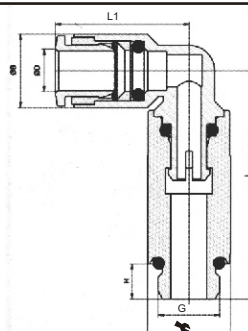

**Артикул T22LC**

**Фитинг цанговый угловой высокий поворотный**

Технополимер; Серия "Теспо-RAP"

(пустотельный болт из никелированной латуни)

Код	ØD	G	ØC	B	A	E		
T22LC0418	4	R1/8"	11,0	37,0	7,5	19,0	10	25
T22LC0414	4	R1/4"	11,0	40,0	9,5	19,0	14	25
T22LC0618	6	R1/8"	13,0	39,7	7,5	19,2	12	25
T22LC0614	6	R1/4"	13,0	42,2	9,5	19,2	14	25
T22LC0638	6	R3/8"	13,0	43,7	10,5	19,2	17	25
T22LC0818	8	R1/8"	14,4	44,8	7,5	23,0	14	25
T22LC0814	8	R1/4"	14,4	46,8	9,5	23,0	17	25
T22LC0838	8	R3/8"	14,4	48,5	10,5	23,0	17	25
T22LC1018	10	R1/8"	18,4	54,3	7,5	28,2	17	25
T22LC1014	10	R1/4"	18,4	56,3	9,5	28,2	17	25
T22LC1038	10	R3/8"	18,4	57,3	10,5	28,2	17	25
T22LC1012	10	R1/2"	18,4	60,8	13,5	28,2	21	10
T22LC1214	12	R1/4"	21,0	61,5	7,5	29,5	21	10
T22LC1238	12	R3/8"	21,0	62,5	10,5	29,5	21	10
T22LC1212	12	R1/2"	21,0	65,5	13,5	29,5	21	10

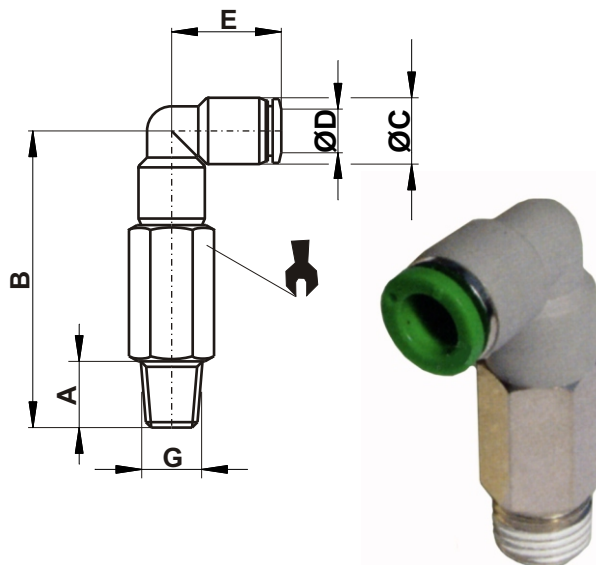

**Артикул T23**

**Тройник-переходник цанговый, тип "Y"**

Технополимер; Серия "Теспо-RAP"

Код	ØD1	ØD2	ØE	ØB	L	A		
T230400	4	4	2,4	9,5	33,0	19,0	50	50
T230406	4	6	2,4	11,5	35,8	19,0	50	50
T230600	6	6	2,6	11,5	38,6	23,0	50	50
T230608	6	8	3,2	13,5	39,8	23,0	50	50
T230800	8	8	2,75	16,5	42,5	27,0	50	50
T230810	8	10	3,2	17,0	44,4	27,0	50	50
T231000	10	10	4,3	20,0	50,8	34,0	25	25
T231012	10	12	4,3	20,0	50,8	34,0	25	25
T231200	12	12	4,2	20,0	53,2	40,0	25	25

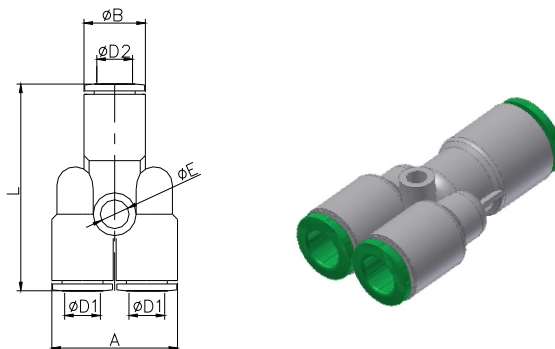

**Артикул T23G**

**Фитинг-тройник цанговый, тип "Y"**

Технополимер; Серия "Теспо-RAP"

(пустотельный болт из никелированной латуни)

Код	ØD	G	ØA	ØB	I	L	A		
T23G04M5	4	M5	2,0	9,5	4,0	29,1	19,0	9	50
T23G0418	4	G1/8"	3,0	9,5	6,0	30,5	19,0	13	50
T23G0414	4	G1/4"	3,0	11,0	9,0	35,5	22,0	17	50
T23G0438	4	G3/8"	3,0	11,0	9,0	46,0	22,0	20	25
T23G0618	6	G1/8"	5,0	11,5	6,0	34,8	23,0	13	50
T23G0614	6	G1/4"	5,0	11,5	8,0	36,4	23,0	16	50
T23G0638	6	G3/8"	5,0	13,0	9,0	47,2	26,0	20	25
T23G0818	8	G1/8"	7,0	13,5	6,0	37,5	27,0	13	50
T23G0814	8	G1/4"	7,0	13,5	8,0	38,6	27,0	16	50
T23G0838	8	G3/8"	6,2	14,4	9,0	50,5	29,4	20	25
T23G1014	10	G1/4"	8,2	18,4	9,0	58,9	36,4	17	25
T23G1038	10	G3/8"	8,2	18,4	9,0	58,9	36,4	20	25
T23G1012	10	G1/2"	8,2	18,4	11,5	62,4	36,4	24	10
T23G1214	12	G1/4"	9,5	21,0	9,0	62,3	42,0	21	10
T23G1238	12	G3/8"	9,5	21,0	9,0	62,3	42,0	21	10
T23G1212	12	G1/2"	9,5	21,0	9,0	65,3	42,0	24	10

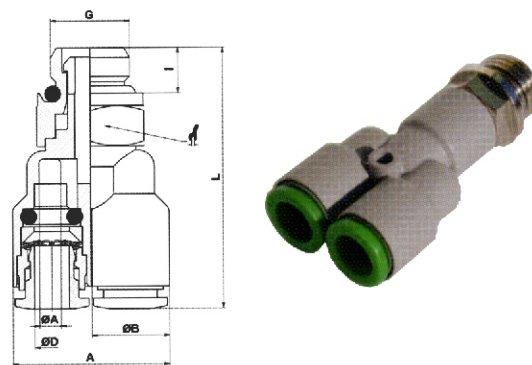

**Артикул T23L0**

**Тройник-переходник цанговый, тип "Y"**

Технополимер; Серия "Теспо-RAP"

(пустотельный болт из никелированной латуни)

Код	ØD1	ØD2	ØB	A	ØE	L	L1		
T2304L0	4	4	9,5	19,0	2,4	50,0	16,7	50	50
T2306L0	6	6	11,5	23,0	2,6	58,1	19,5	50	50
T2308L0	8	8	13,5	27,0	2,75	63,5	21,0	50	50
T2310L0	10	10	17,0	34,0	4,3	74,8	24,0	25	25
T2312L0	12	12	20,0	40,0	4,2	78,2	25,0	25	25

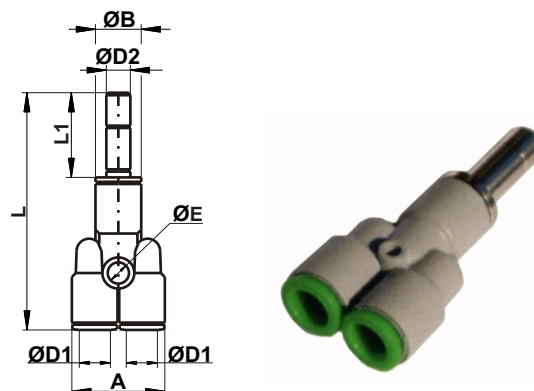

1

1

**Артикул T24**

**Коллектор-переходник цанговый, тип "2Y"**

Технополимер; Серия "Теспо-RAP"

Код	ØD1	ØD2	ØE	ØB	L		
T240400	4	4	3,2	9,5	34,0		25
T240406	4	6	3,2	11,5	36,8		25
T240408	4	8	3,2	13,5	36,8		25
T240600	6	6	3,2	11,5	39,6		25
T240608	6	8	3,2	13,5	41,8		25
T240800	8	8	3,2	13,5	43,5		25
T240810	8	10	3,2	17,0	46,5		25

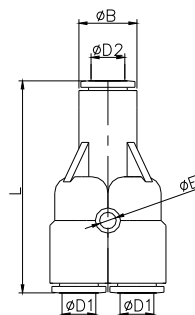

**Артикул T24L0**

**Коллектор-переходник цанговый, тип "2Y"**

Технополимер; Серия "Теспо-RAP"

(пустотелый болт из никелированной латуни)

Код	ØD1	ØD2	ØB	A	ØE	L	L1		
T2404L0	4	4	9,5	19,0	2,4	51,2	16,7		25
T2406L0	6	6	11,5	23,0	2,6	59,1	19,5		25
T2408L0	8	8	13,5	27,0	2,75	67,5	21,0		25

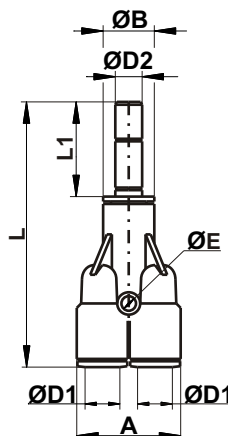

**Артикул T11**

**Четверник (крест) цанговый**

Технополимер; Серия "Теспо-RAP"

Код	ØD	ØB	ØA	C		
T110400	4	9,5	17,2	3		50
T110600	6	11,5	20,8	3		50
T110800	8	13,5	23	3		50
T111000	10	17	6,5	3		50
T111200	12	20	28,8	3		50

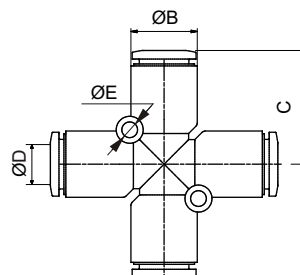

**Артикул 27**

**Фитинг-картридж цанговый**

Латунь; Серия "RAP"

(предназначен для запрессовки в изделия из пластмассы)

Код	ØD	ØC	ØB	H		
270400	4	2,9	7,8	14,0		100
270600	6	5,0	10,0	16,0		50
270800	8	7,0	11,8	17,0		50

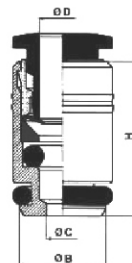





Цанговые фитинги серий "RAP" и "Теспо-RAP".  
Резьбы M5 - G1/2". Трубки 4 - 14 мм.



**Артикул 33А**

**Двухуровневый пустотелый болт с уплотнительными кольцами**  
Никелированная латунь; Серия "RAP"

Код	G	L	⌀	⌀	⌀
33А18	G1/8"	43,8	14	3,0	50
33А14	G1/4"	51,5	18	4,0	50

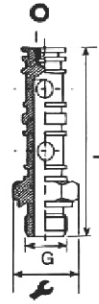

1

1

**Артикул 33**

**Коллектор цанговый двухуровневый поворотный**  
Никелированная латунь; Серия "RAP"

Код	ØD	G	ØA	H	L <sub>1</sub>	L	⌀	⌀	⌀
330418	4	G1/8"	5,5	6,0	43,8	21,1	14	3,0	25
330618	6	G1/8"	5,5	6,0	43,8	24,3	14	3,0	25
330818	8	G1/8"	5,5	6,0	43,8	24,8	14	3,0	25
330614	6	G1/4"	7,8	8,0	51,5	25,5	18	4,0	25
330814	8	G1/4"	7,8	8,0	51,5	26,5	18	4,0	25
331014	10	G1/4"	7,8	8,0	51,5	28,4	18	4,0	25

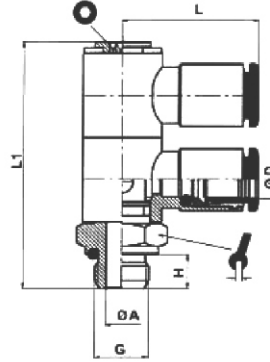

**Артикул Т33**

**Коллектор цанговый двухуровневый поворотный**  
Технополимер; Серия "Теспо-RAP"  
(пустотелый болт из никелированной латуни)

Код	ØD	G	ØA	H	L <sub>1</sub>	L	⌀	⌀	⌀
Т330418	4	G1/8"	5,5	5,5	43,3	21,1	14	3,0	25
Т330618	6	G1/8"	5,5	5,5	43,3	24,3	14	3,0	25
Т330614	6	G1/4"	7,8	6,5	50,0	25,5	18	4,0	25
Т330818	8	G1/8"	5,5	5,5	43,3	24,8	14	3,0	25
Т330814	8	G1/4"	7,8	6,5	50,0	26,5	18	4,0	25
Т331014	10	G1/4"	7,8	6,5	50,0	28,4	18	4,0	25

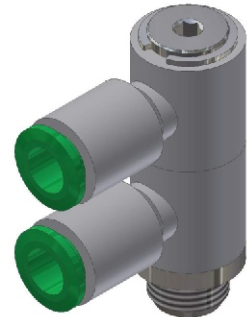
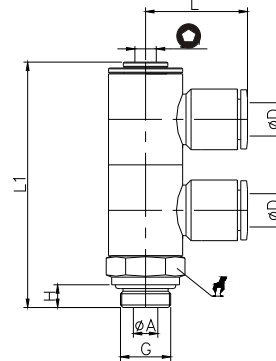

**Артикул Т33В**

**Коллектор цанговый двухуровневый сдвоенный поворотный**  
Технополимер; Серия "Теспо-RAP"  
(пустотелый болт из никелированной латуни)

Код	ØD	G	ØA	H	L <sub>1</sub>	L	⌀	⌀	⌀
Т33В0618	6	G1/8"	5,5	5,5	43,3	24,3	14	3,0	10
Т33В0814	8	G1/4"	7,8	6,5	50,0	26,5	18	4,0	10

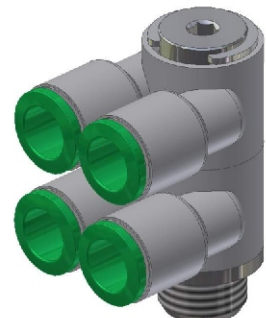
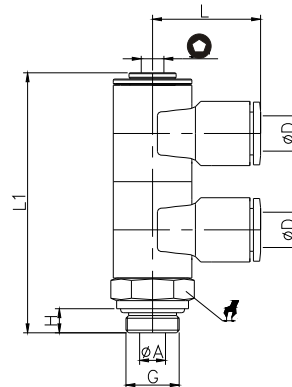

**Артикул 34А**

Трехуровневый пустотелый болт с уплотнительными кольцами

Никелированная латунь; серия "RAP"

Код	G	L			
34A18	G1/8"	59,0	14	3,0	50
34A14	G1/4"	67,0	18	4,0	50

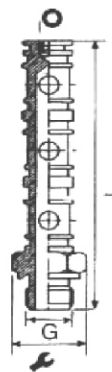

1

1

**Артикул 34**

Коллектор цанговый трехуровневый поворотный

Никелированная латунь; серия "RAP"

Код	ØD	G	ØA	H	L <sub>1</sub>	L			
340418	4	G1/8"	5,5	6,0	59,0	21,1	14	3,0	10
340618	6	G1/8"	5,5	6,0	59,0	24,3	14	3,0	10
340818	8	G1/8"	5,5	6,0	59,0	24,8	14	3,0	10
340614	6	G1/4"	7,8	8,0	67,0	25,5	18	4,0	10
340814	8	G1/4"	7,8	8,0	67,0	26,5	18	4,0	10
341014	10	G1/4"	7,8	8,0	67,0	51,5	18	4,0	10

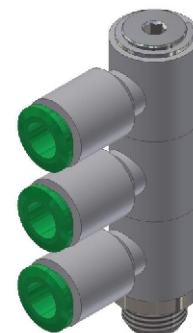
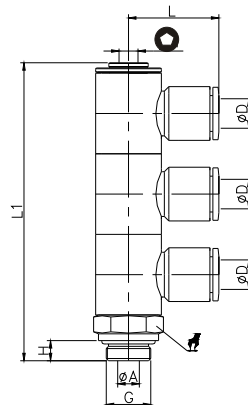

**Артикул Т34**

Коллектор цанговый трехуровневый поворотный

Технополимер; серия "Теспо-RAP"

(пустотелый болт из никелированной латуни)

Код	ØD	G	ØA	H	L <sub>1</sub>	L			
T340418	4	G1/8"	5,5	5,5	58,0	21,1	14	3,0	10
T340618	6	G1/8"	5,5	5,5	58,0	24,3	14	3,0	10
T340818	8	G1/8"	5,5	5,5	58,0	24,8	14	3,0	10
T340614	6	G1/4"	7,8	8	67	25,5	18	4,0	10
T340814	8	G1/4"	7,8	8	67	26,5	18	4,0	10
T341014	10	G1/4"	7,8	8	67	28,4	18	4,0	10

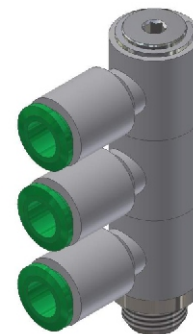
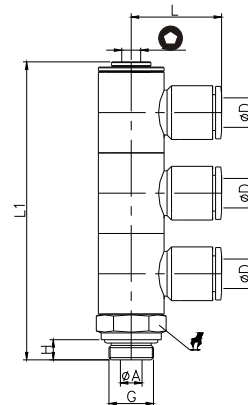

**Артикул Т34В**

Коллектор цанговый трехуровневый сдвоенный поворотный

Технополимер; серия "Теспо-RAP"

(пустотелый болт из никелированной латуни)

Код	ØD	G	ØA	H	L <sub>1</sub>	L			
T34B0618	6	G1/8"	5,5	5,5	58,0	24,3	14	3,0	10
T34B0814	8	G1/4"	7,8	8,0	67,0	26,5	18	4,0	10

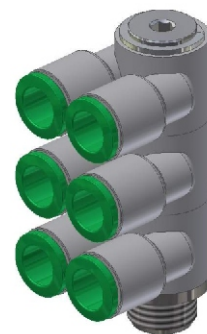
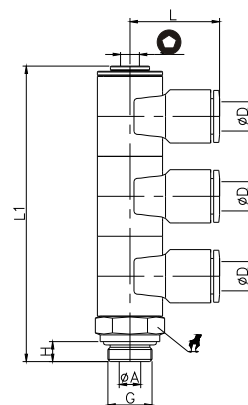

## Описание

Цанговые фитинги для систем смазки используются либо с пластиковыми трубками с внешним диаметром 4мм или 6мм, либо со стальными трубами с внешним диаметром 4мм или 6мм, имеющими канавку (см. чертёж 1 ниже).

## Пример монтажа цангового фитинга

Все прямые фитинги с наружной резьбой имеют внутренний шестигранник (Ch B) для облегчения монтажных работ.

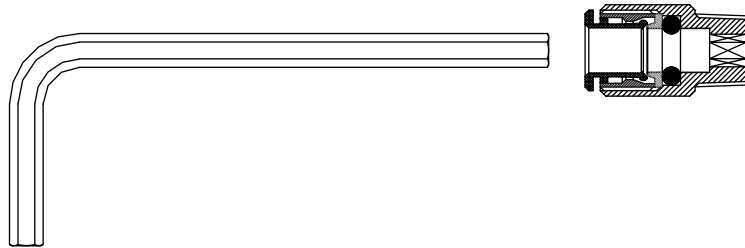

Перед установкой трубки в фитинг, убедитесь, что торец не имеет заусенцев, а сечение трубки круглое. При использовании металлической трубки, на ней необходимо сделать канавку. В этом случае фитинг будет лучше удерживать трубку.

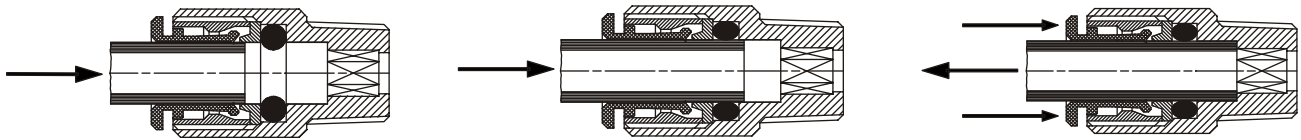

При установке трубки в фитинг убедитесь, что трубка прошла через цанговый зажим и уплотнительное кольцо.

## Извлечение трубки

Нажмите на кольцо цанги и, удерживая его нажатым, потяните за трубку.

## Пример исполнения канавки на металлических трубках Ø4мм и Ø6мм (чертёж 1)

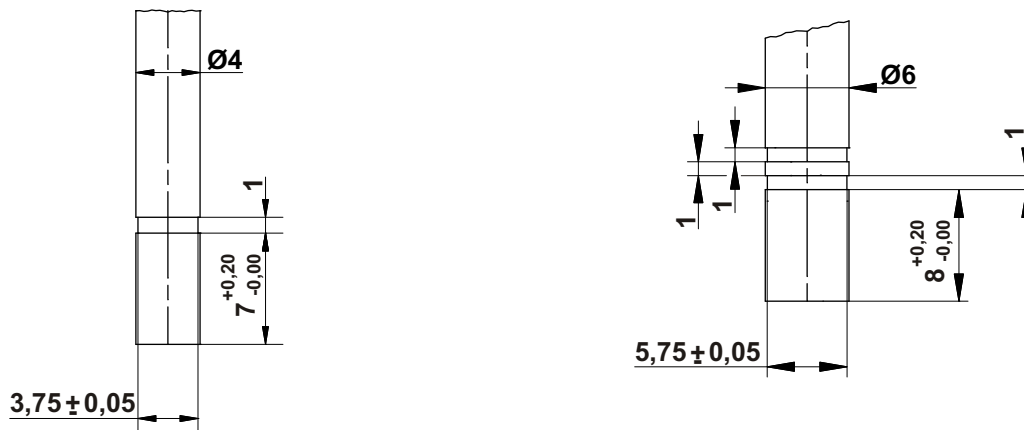

1

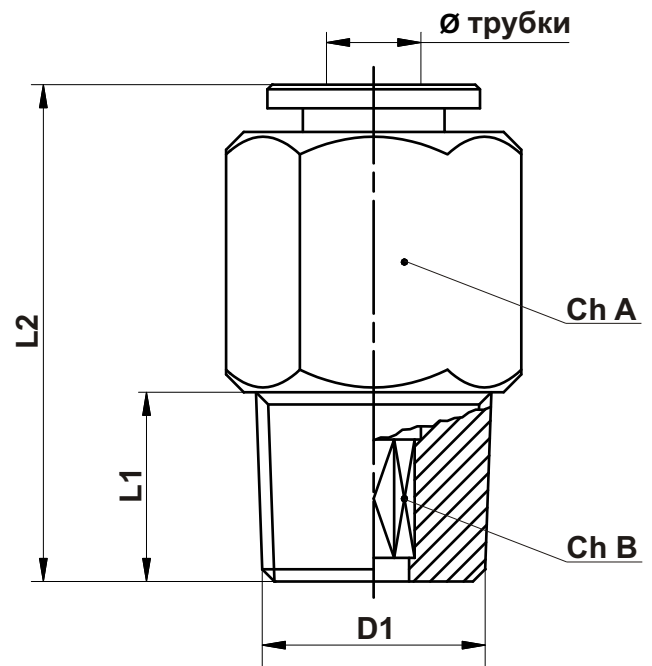
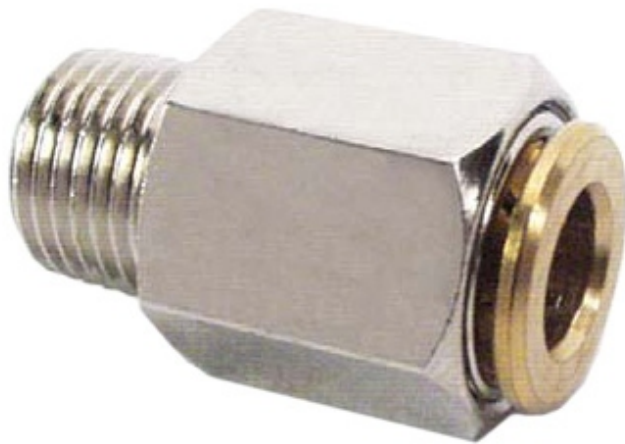

1

### Технические характеристики

<b>Материал</b>	Никелированная латунь
<b>Рабочее давление</b>	250бар (25МПа)
<b>Давление разрушения</b>	Свыше 1000бар (100МПа)
<b>Диапазон температур</b>	От -20°C до +120°C
<b>Тип смазки</b>	Жидкая, полужидкая, пластичная
<b>Внутреннее уплотнение</b>	NBR, "0" - кольцо , 90Sh

### Коды для заказа

Код	Ø, мм	D1	L1	L2	Ch A	Ch B
03.255.0	4	R 1/8"	8	21	10	3,0
03.255.1	4	M6x1	8,0	25	10	2,5
03.255.2	4	M8x1	8,0	22	10	3,0
03.257.5	4	UNF 5/16"	8,0	22	10	3,0
03.255.3	4	M10x1	8,0	21	11	3,0
03.255.4	4	M6x0,75	6,0	23	10	2,5
03.256.0	6	R 1/8"	8	26	12	4,0
03.256.1	6	M6x1	8,0	28	12	2,5
03.256.2	6	M8x1	8,0	28	12	4,0
03.257.6	6	UNF 5/16"	8,0	28	12	4,0
03.256.3	6	M10x1	8,0	24	12	4,0
03.256.4	6	M12x1	9,0	25	13	4,0
03.257.4	6	R 1/4"	11,0	26	14	4,0

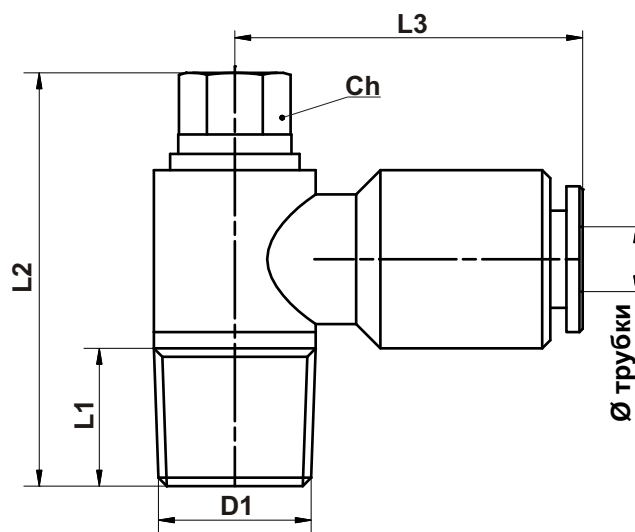

### Технические характеристики

<b>Материал</b>	Никелированная латунь
<b>Рабочее давление</b>	250бар (25МПа)
<b>Давление разрушения</b>	Свыше 1000бар (100МПа)
<b>Диапазон температур</b>	От -20°C до +120°C
<b>Тип смазки</b>	Жидкая, полужидкая, пластичная
<b>Внутреннее уплотнение</b>	NBR, "0" - кольцо , 90Sh

### Коды для заказа

Код	Ø, мм	D1	L1	L2	L3	Ch
03.255.5	4	M6x1	8,0	26	22	6
03.257.0	4	M6x0,75	6,0	24	22	6
03.255.6	4	M8x1	8,0	26	22	6
03.257.7	4	UNF 5/16"	8,0	26	22	6
03.255.7	4	R 1/8"	7,5	25	22	6
03.255.8	4	M10x1	8,0	26	22	6
03.256.5	6	M6x1	8,0	26	24	6
03.256.6	6	R 1/8"	7,5	25	24	6
03.257.1	6	M8x1	8,0	26	24	6
03.257.8	6	UNF 5/16"	8,0	26	24	6
03.256.7	6	M10x1	8,0	26	24	6
03.256.8	6	M12x1	9,0	26	24	6
03.257.2	6	G 1/4"	размеры смотрите на странице 3-11/2			